

Article number: 03469010

Description: Fluro Rod end EA 10D-NIRO

Note: 10

Measures

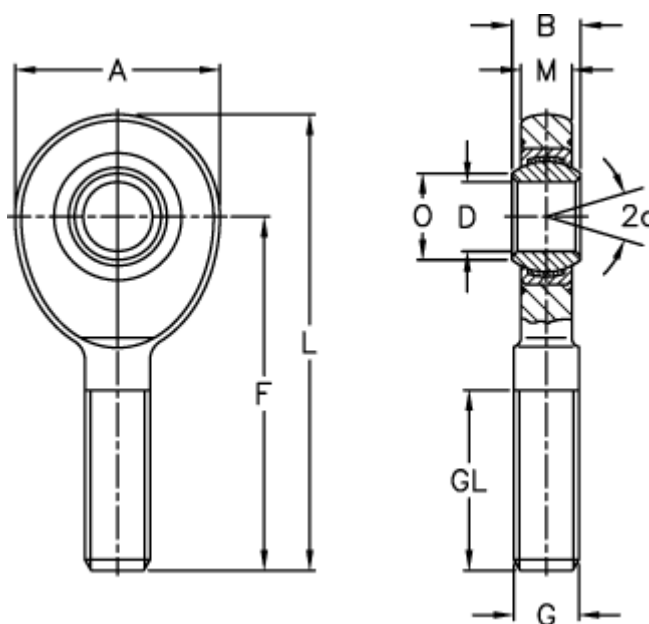

A	= 28	L	= 62
a (degrees)	= 12	M	= 7
B	= 9	O	= 13.2
D	= 10	Static drive kN	= 11.6
Dynamic drive (kN)	= 10	Weight	= 50
F	= 48		
g	= M10		
GL	= 26		